



Project	
Date	
Prepared by	
Model #	LHB3-904-2-W210

# LHB3-SERIES LINEAR HIGH BAY



## OVERVIEW

The LHB3-Series Linear High Bay provides high efficacy and energy savings to projects that require optimized lighting in high ceiling applications. Available in both regular or narrow form factors, these linear high bays are the energy efficient replacements for traditional fluorescent fixtures and HID highbays.

## PRODUCT HIGHLIGHTS

- High Efficacy
- Frosted Diffuser for soft, uniform light output
- 1-10V Dimmable
- Instant start, no flickering or humming
- Chain kit included
- Optional mounting options: pendant mount kit, threaded rod kit, ganging kit
- Optional accessories: wireguards



### OPTICAL SPECIFICATIONS

Lumen Output (lm)	12000 lm	Beam Angle (°) <sub>1</sub>	100°
CCT (K)	4000K	Projected Lifetime (L <sub>70</sub> )	50,000 hours
CRI (Ra)	82	Chromaticity Shift (K)	3710K~4260K
Efficacy (lm/W)	135 lm/W		

### ELECTRICAL SPECIFICATIONS



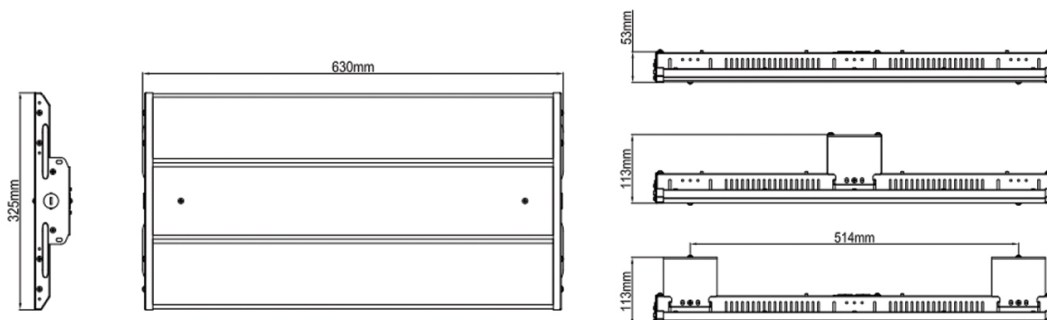

Power	90W	Output Voltage (VDC)	22-56V
Apparent Power (VA)	91.3VA	Current Draw at 277V <sub>AC</sub> (A)	0.325A
System Wattage (W)	89W	Current Draw at 347V <sub>AC</sub> (A)	0.259A
Input Voltage	277-480VAC	Current Draw at 480V <sub>AC</sub> (A)	0.1875A

### PRODUCT DIMENSIONS



CONSTRUCTION		LED AND DRIVER SPECIFICATIONS	
Housing Material	Iron	LED Type	2835
Housing Color	White	Dimmable	1-10V
Lens Material	PC	Output Voltage (VDC)	22-56V
Dimensions (inch/mm)	24.8" x 12.8" x 2.09" 630mm x 325mm x 53mm	Power Factor	0.927
Installation Method	Includes 10-foot white cord Surface Mounting Chain Kit (included) Pendant Kit (optional) Thread Rod Kit (optional) Ganging Kit (optional)	THD	8.40%
		Surge Protection	L-N:6KV L/N-PE:10KV
		Inrush Current (A)	277V(MAX30A)/347V (MAX38A)/480V(MAX55A)
Weight (kg/lbs)	4.6KG/10.14LBS	Driver Class	Class 2
Operation Range (°F/°C)	-40°C to 50°C / -40°F to 122°F"	APPROVALS AND LISTINGS	
Warranty	10 Years	DLC Premium	PWSJFG61
		UL/ETL	cULus

### OPTIONAL ACCESSORIES

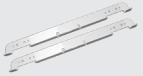
	<b>LHB-WG3</b>	Wireguards for 90W, 135W, 165W models		<b>LHB-TRSMK23</b>	Surface Mount/Threaded Rod Kit for 277-480V models
	<b>LHB-PMK23</b>	Pendant Mount Kit for 277-480V models		<b>LHB-ACK3</b>	Aircraft Cable Kit for all models
	<b>LHB-GK3</b>	Ganging Kit for all models			

### CANDELA ILLUMINANCE AT A DISTANCE

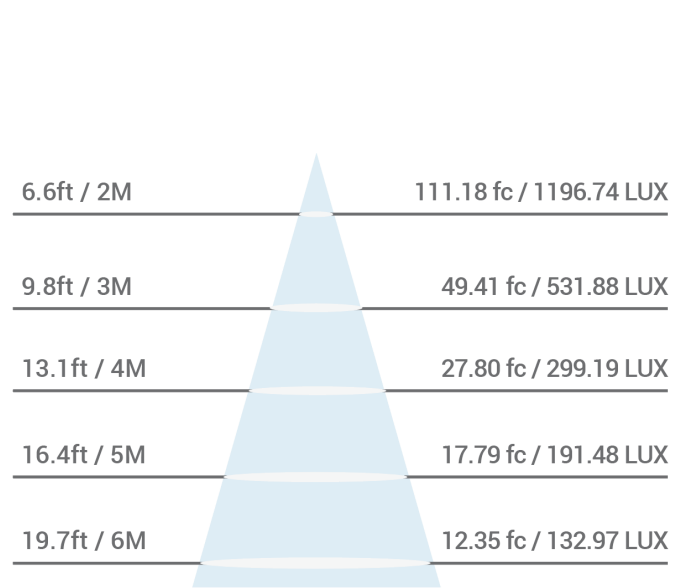
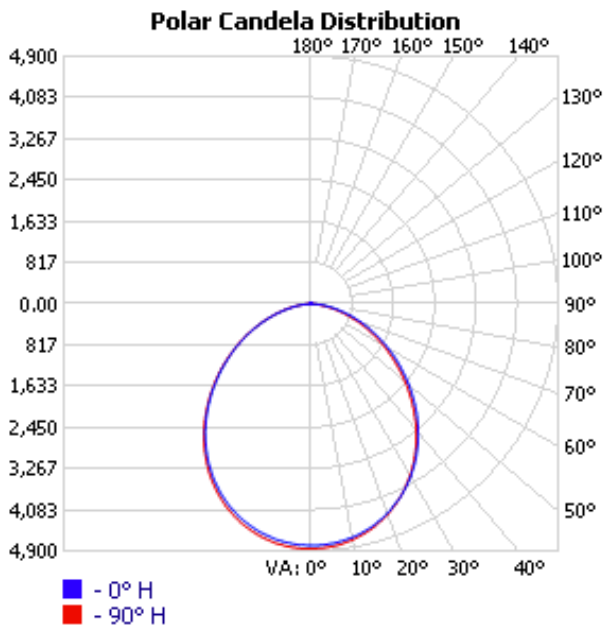

## PRODUCT KEY

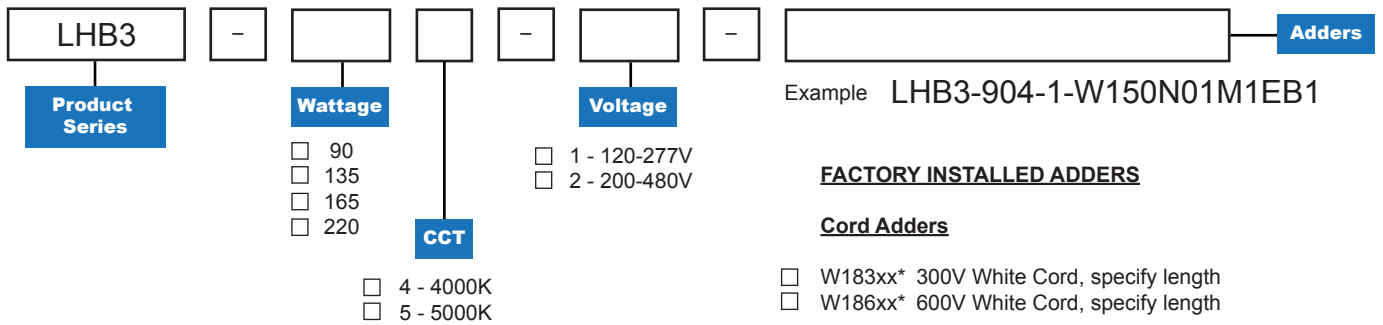

### FACTORY INSTALLED ADDERS

#### Cord Adders

- W183xx\* 300V White Cord, specify length
- W186xx\* 600V White Cord, specify length

\*xx denotes cord length in feet. The LHB3-Series comes with a pre-installed 10 foot cord. If a different length is required, indicate the cord length based on number of feet required.

#### Cord End Adders

- N01 5-15P 125V 15A Straight Plug
- N02 6-15P 250V 15A Straight Plug
- N04 L5-15P 125V 15A Locking Plug
- N05 L6-15P 250V 15A Locking Plug
- N06 L7-15P 277V 15A Locking Plug
- N07 5-20P 125V 20A Straight Plug
- N08 6-20P 250V 20A Straight Plug
- N09 7-20P 277V 20A Straight Plug
- N10 L5-20P 125V 20A Locking Plug
- N11 L6-20P 250V 20A Locking Plug
- N12 L7-20P 277V 20A Locking Plug
- N13 L24-20P 347V 20A Locking Plug
- N14 L8-20P 480V 20A Locking Plug

#### Motion Sensor Adders

- M1 PIR Motion Sensor (ON/OFF)
- M4 Microwave Motion Sensor 120-277V
- M5 Microwave Motion Sensor 347-480V

#### Emergency Battery Adders

- EB1 20W Emergency Battery Backup (100-277V only)

### Cord and Sensor Installation Position

When ordering, please specify the knockout positions for cords and sensors.

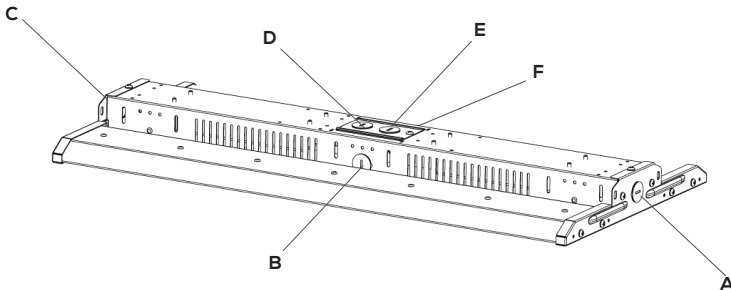

1. Due to the special conditions of manufacturing, the typical data of optical specifications can only reflect statistical figures and do not necessarily correspond to the actual parameters of each single product which could differ from the typical data.  
 2. Exceeding maximum ratings for input voltage and current will cause hazardous overload and will likely destroy the LED fixture.  
 3. Refer to Warranty Terms & Conditions available at [premiseled.com/warranty](http://premiseled.com/warranty)